

innews



Modernizzando
Modernizing

ASTRA

ineus

Index



AUTENTICO CONFORT LAVORATIVO

Il design di INEUS è un insieme di intuizioni formali e funzionali che descrivono un cambiamento radicale di come conosciamo il "mobile". Con INEUS descriviamo il desiderio di uno studio che abbia stile ma che sappia rispondere con soluzioni concrete a delle esigenze specifiche, mantenendo in primo piano design e ambizioni estetiche. Ecco perché in questa linea ritroviamo la spinta funzionale dell'approccio moderno alla progettazione accanto ad intuizioni formali del tutto innovative, quasi inaspettate. Questo equilibrio tra efficienza formale e identità estetica rende INEUS intramontabile.

AUTHENTIC WORKPLACE COMFORT

The design of INEUS is a synthesis of formal and functional insights, representing a radical shift in how we perceive "furniture." With INEUS, we fulfill the desire for a workspace that combines style with concrete, solution-driven responses to specific needs, prioritizing design and aesthetic ambition. This line embodies the functional drive of modern design approaches, paired with entirely innovative, almost unexpected, formal insights. This balance between formal efficiency and aesthetic identity makes INEUS timeless.

2	Ineus #1	METAMORFOSI D'IMPATTO IMPACTFUL TRANSFORMATION	
10	Ineus #2	INCANTESIMI DI LUCE SPELLS OF LIGHT	
18	Ineus #3	L'ESSENZA DELL'UNICITÀ THE ESSENCE OF UNIQUENESS	
26	PARTE TECNICA TECHNICAL PART		
36	Ineus #4	IL LUSSO DELLA SEMPLICITÀ THE LUXURY OF SIMPLICITY	
44	Ineus #5	I SEGNI DEL TEMPO TIMELESS DESIGN	



Ineus #1

METAMORFOSI D'IMPATTO

Il carrello è un mobile ausiliario versatile e indispensabile nello studio. Nella linea INEUS la nuova maniglia "Linea" e il basamento di design lo rendono un elemento più moderno spezzando i paradigmi della classicità.

IMPACTFUL TRANSFORMATION

The mobile unit is a versatile and indispensable auxiliary element for the practice. In the INEUS line, the new "Linea" handle and the designer base transform it into a modern piece that breaks away from traditional paradigms.







INEUS vista con toni accesi o tinte neutre, design essenziale con forme ricercate, la costante è determinata con autentica qualità e massima libertà di accostamento, due ingredienti imprescindibili per una progettazione a 360°.

INEUS is available in vibrant tones or neutral shades, with an essential design and refined forms. The constant factor is genuine quality and maximum freedom in combinations—two essential ingredients for 360° design.



Ineus #2

INCANTESIMI DI LUCE

Lo spazio dove la luce merita attenzione e senza dubbio lo studio, non solo per la sua funzione estetica ed emotiva ma soprattutto per il suo aspetto pratico e funzionale, per questo è possibile dotare i contenitori di illuminazione integrata, in particolare i pensili possono avere i perimetri completamente illuminati.

SPELLS OF LIGHT

The practice is where lighting truly matters—not only for its aesthetic and emotional impact but also for its practical and functional role. That's why the cabinets in the INEUS line can feature integrated lighting. In particular, the wall units may have fully illuminated perimeters.



INEUS nasce dalla volontà di realizzare una linea di arredo dove l'aspetto razionale fosse il fattore guida del progetto rinnovandone però i contenuti.

INEUS emerges from the ambition to create a furniture line where rationality is the guiding principle of the project while renewing its contents.





Dettaglio del cassettone lavello singolo con contenitori raccolta.

Single sink drawer unit with bins for waste material.



Dettaglio del cassettone lavello doppio con contenitori raccolta e spazio aggiuntivo stoccaggio.

Double sink drawer unit with bins for waste material and additional storage space.



Scrivania cassetto integrata alla composizione, una soluzione funzionale e smart per il PC, dove gli spazi sono ridotti ed essenziali.

Desk drawer integrated into the composition—a functional and smart solution for the PC in compact and essential spaces.



Ineus #3

L'ESSENZA DELL'UNICITÀ

La sapienza artigiana si coniuga con le moderne esigenze di funzionalità.
Soluzione tecnica ma sempre creativa, cassetto estraibile elettrificato e soluzione scrivania per spazi limitati. Zoccolo con inserto led per dare maggior luce al tuo ambiente.

THE ESSENCE OF UNIQUENESS

Craftsmanship blends seamlessly with modern functional demands.
A technical yet creative solution, featuring an electrified pull-out drawer and a desk solution for compact spaces. The plinth incorporates a LED strip to brighten your environment.



INEUS in soli due metri il tuo studio completo anche nei dettagli, vano scrivania, mobile apparecchi elettrici vetrina dispenser, capienti cassetti ad estrazione totale, mobile lavello con raccolta differenziata e luci led.

In just two meters, INEUS offers a complete practice down to the finest details: desk space, unit for electric equipment, and hanging unit for disposable material. Spacious full-extension drawers, a sink unit with waste collection, and LED lighting.



INEUS versatile anche nella scelta delle aperture pensili, a ribalta ma con soluzione meccanica e ad anta ma con cerniere invisibili.

INEUS is versatile even in the choice of wall unit openings, offering flip-up mechanisms or hinged doors with invisible hinges.





ARREDO CREATIVO

Con la linea INEUS abbiamo cercato di rompere gli schemi creando arredi razionali ma con uno spiccato senso di design e creatività. I mobili della linea INEUS hanno linee asciutte ma mai banali, funzionali ma allo stesso tempo decorative in un modo discreto e soprattutto moderno con una maggiore facilità d'uso e maggior confort.

CREATIVE FURNITURE

With the INEUS line, we've broken boundaries by creating rational furniture imbued with a strong sense of design and creativity. The furniture in the INEUS line features clean lines that are never dull, functional yet discreetly decorative, thoroughly modern, and designed for ease of use and enhanced comfort.

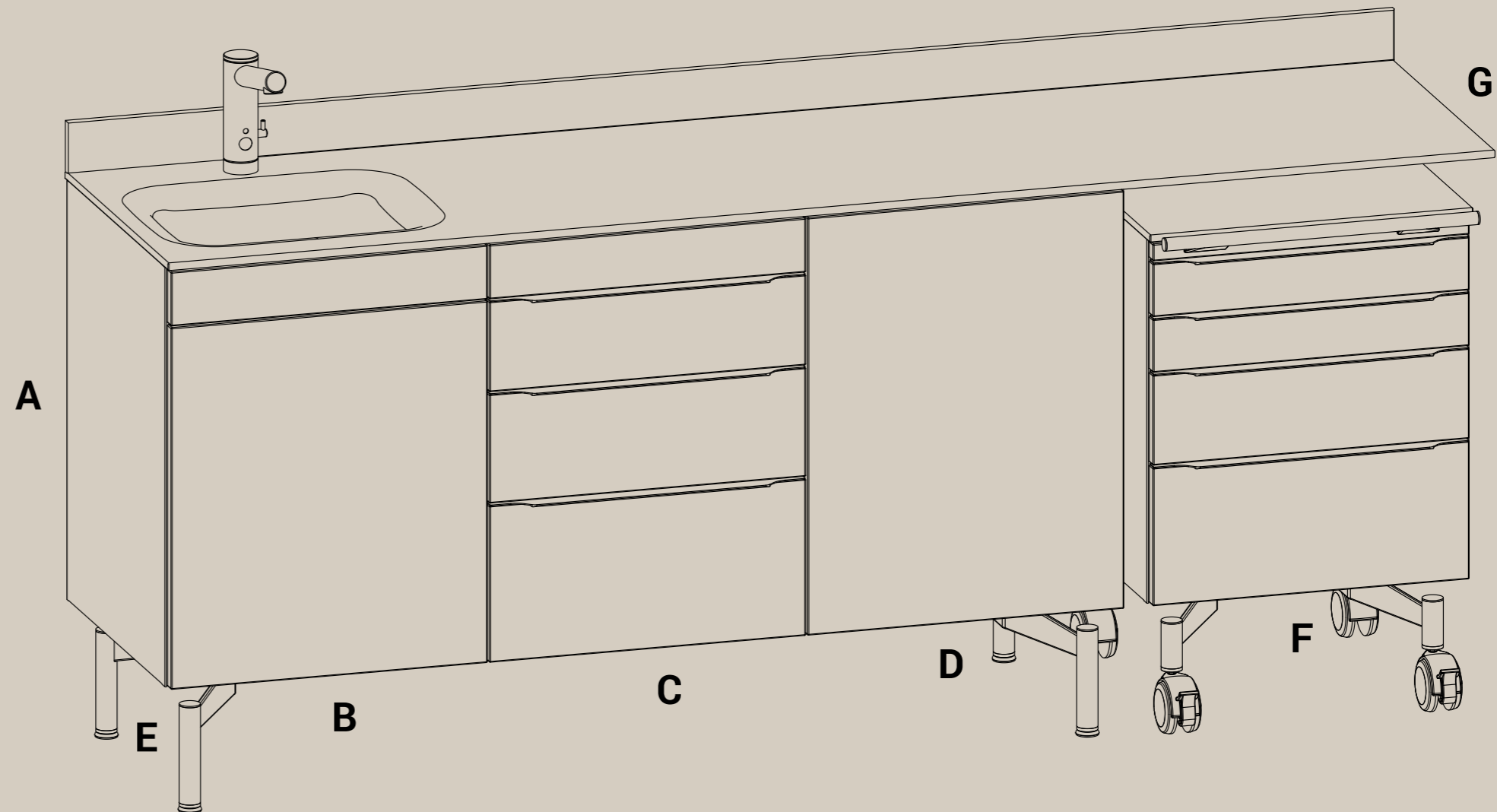
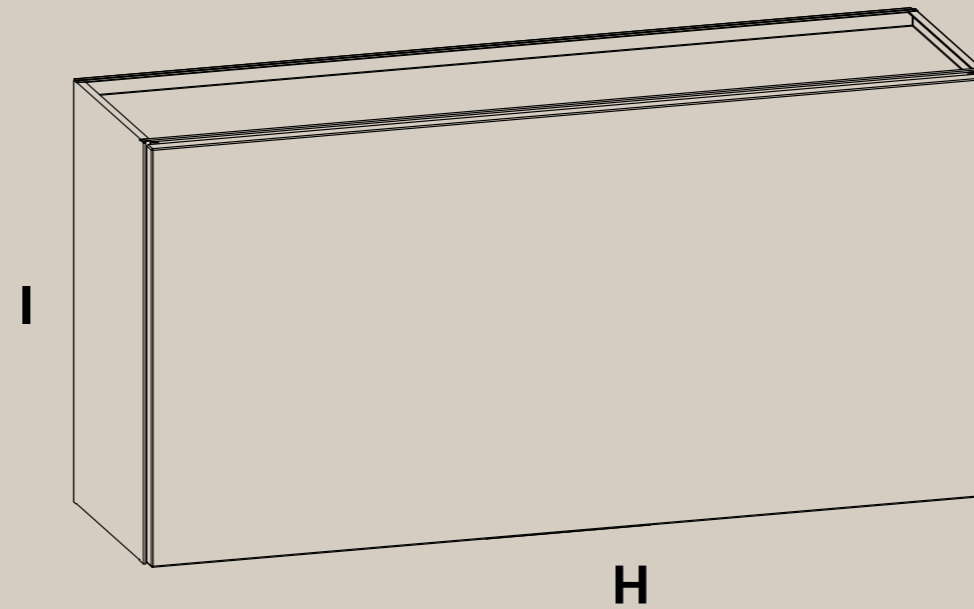

A
Fianco mobile destro-sinistro
Cabinet Side Panel Right-left

B
Mobile lavello
Sink unit

C
Mobile 4 cassetti
4-drawer unit

D
Mobile anta
Door Unit

E
Telaio base 3 mobili
Base frame for 3 units

F
Servomobile 4 cassetti
4-drawer mobile unit

G
Telaio supporto Piano
Support frame for Worktop

H
Vetrina dispenser sinistra
*Hanging Unit for Disposable
Material, Left*

I
Fianchi vetrina destro-sinistro
*Side Panels for Hanging Unit,
Right-Left*

Basi 655 livello / Sink Units 655

Base 655 angolare / Corner Unit 655

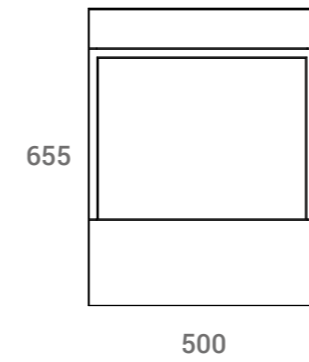
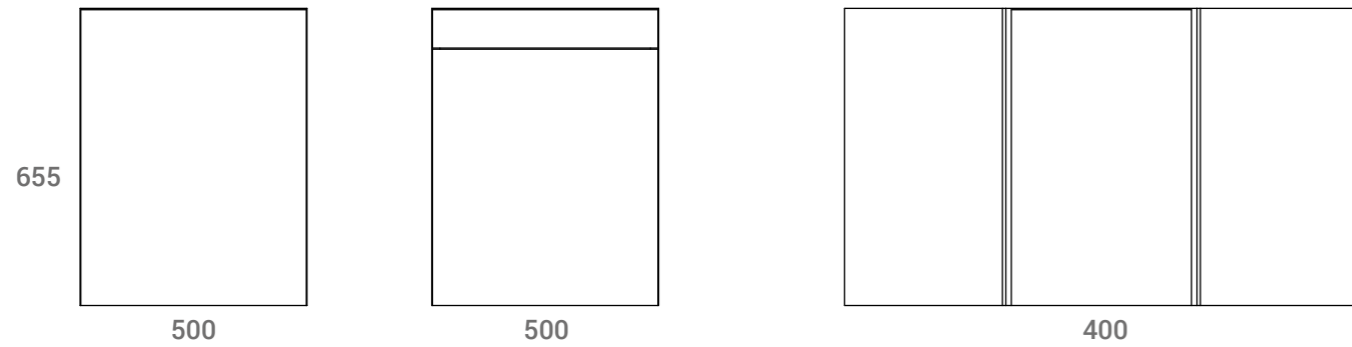

Basi 655 / Standard Units 655

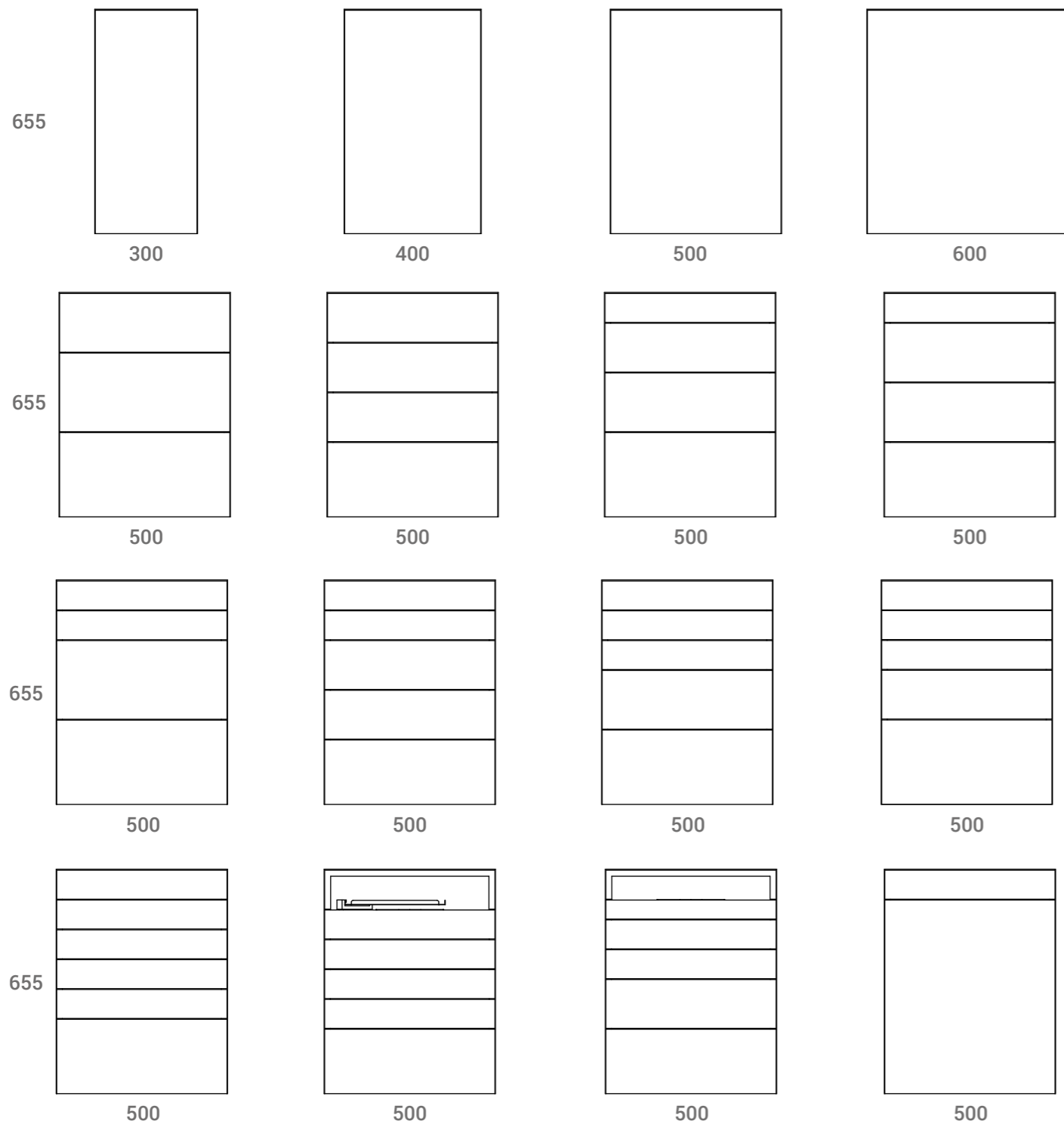

FATTI CONSIGLIARE

| Accedi al QR qui a fianco e scegli la tua composizione INEUS tra quelle scelte da ASTRA.

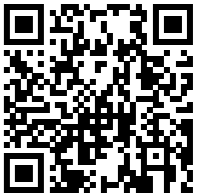

GET RECOMMENDED OPTIONS

| Scan the QR code to choose your INEUS composition from the configurations selected by ASTRA.

Fianchi - Tamponamenti basi 655 / Side Panels 655

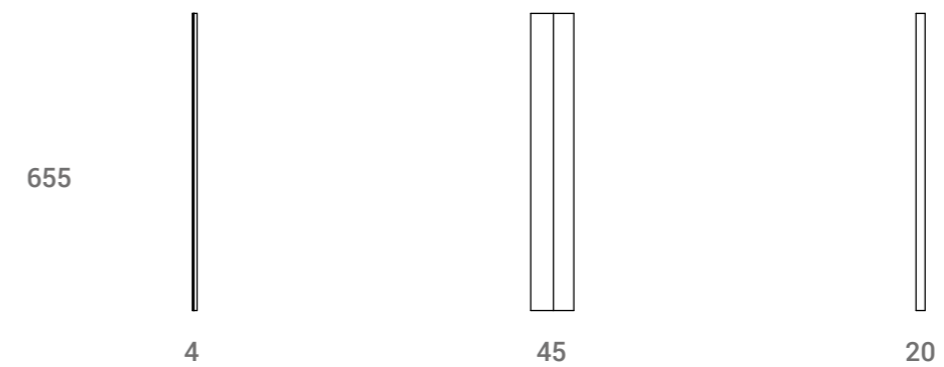

Telai basi 655 / Supporting Structure 655

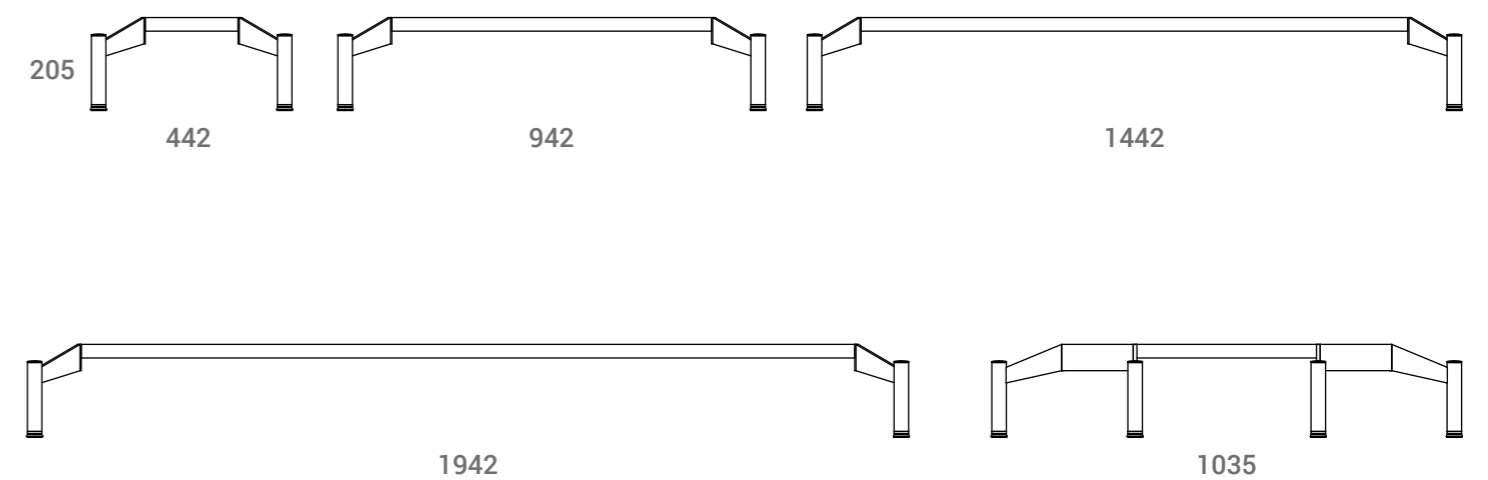

Basi 742 livello / Sink Units 742

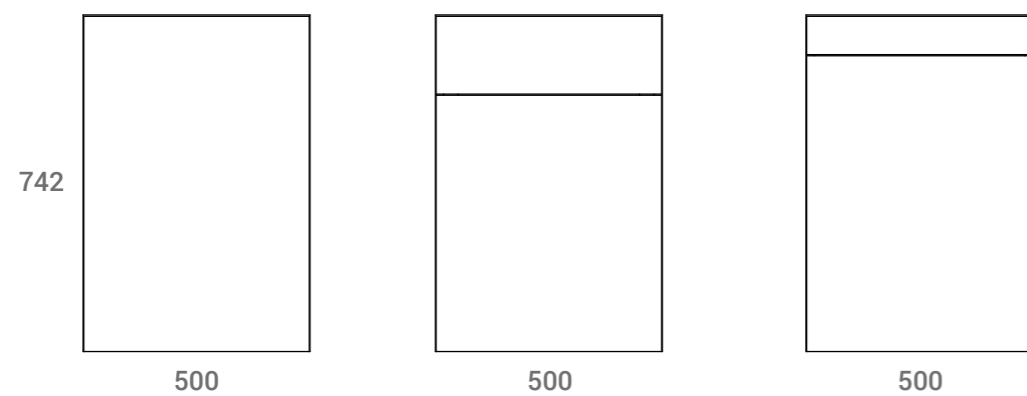

Base 742 angolare / Corner Unit 742

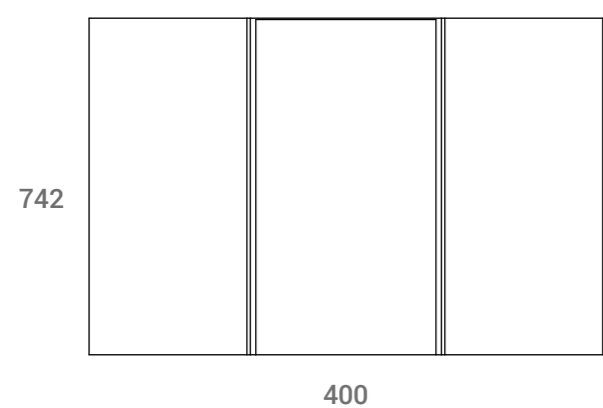

Basi 742 / Standard Units 742

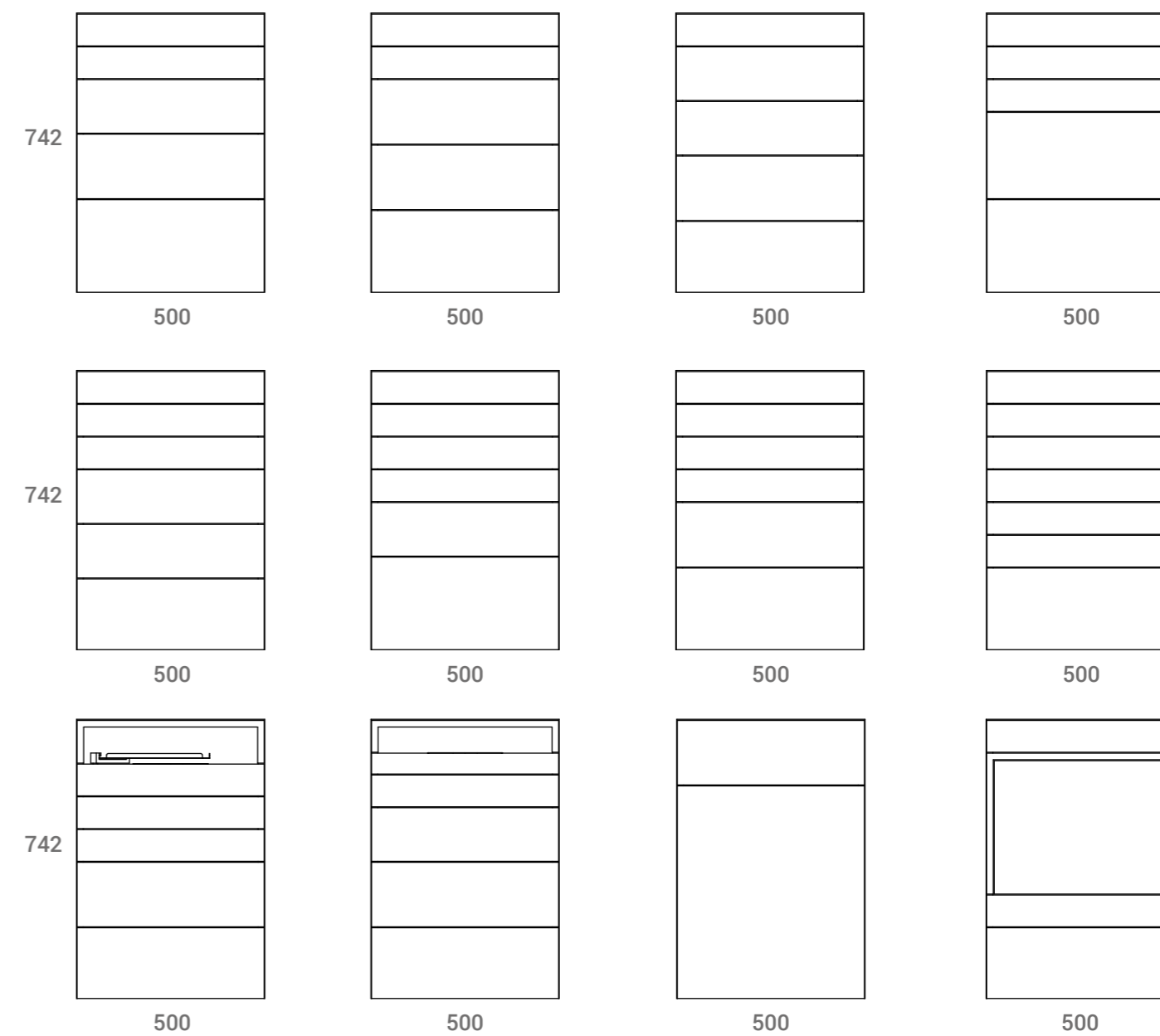
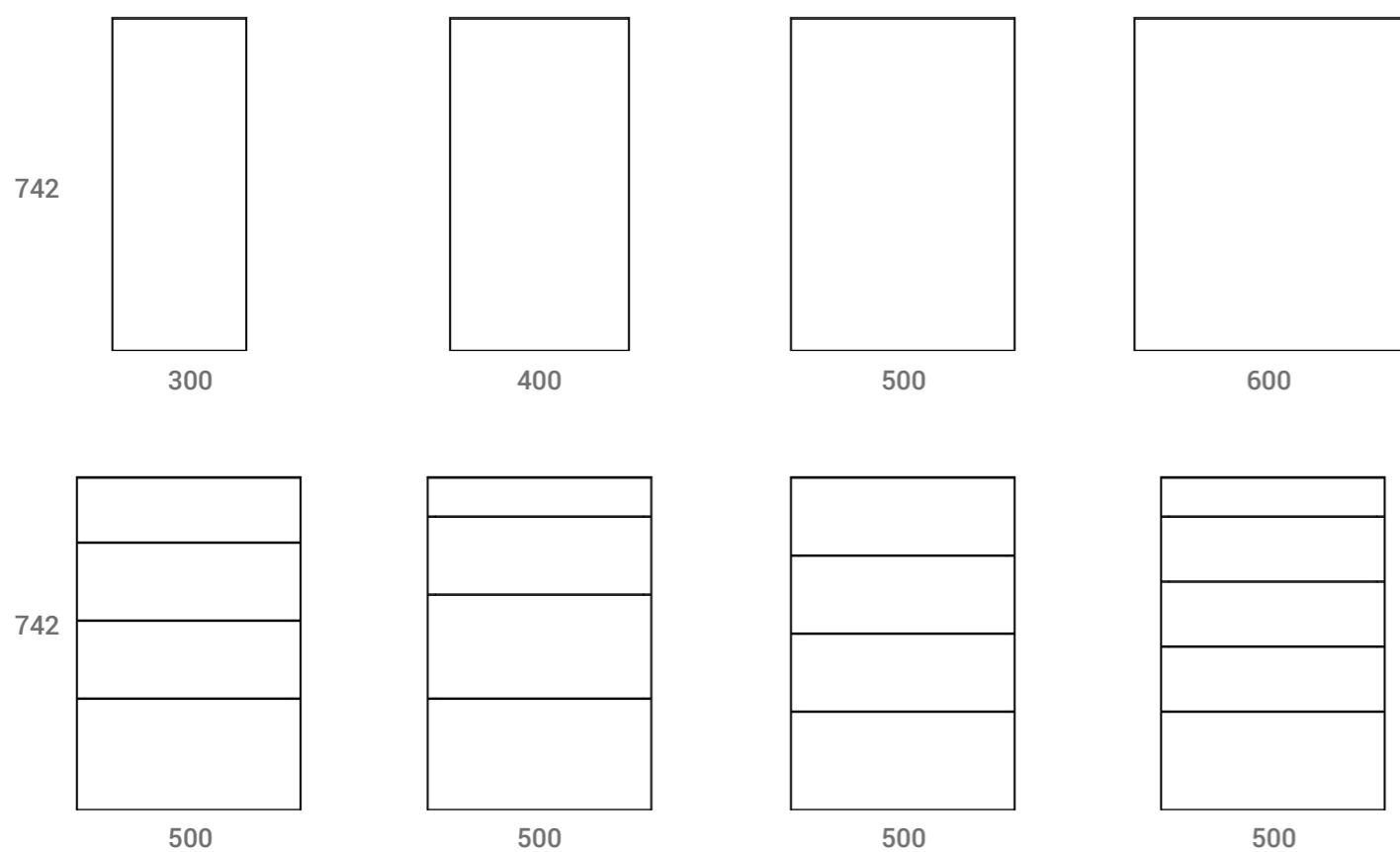

Fianchi - Tamponamenti basi 742 / Side Panels 742

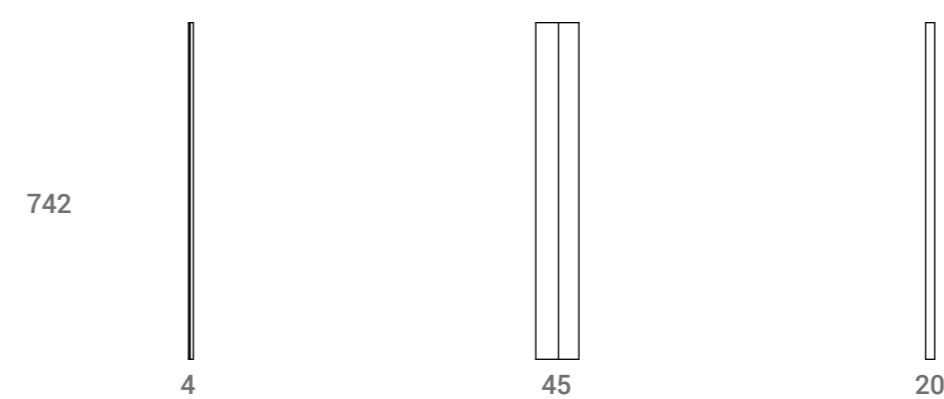

Piedi - Zoccolo basi 742 / Bases for Feet - Plinth 742



Servomobili / Mobile Units

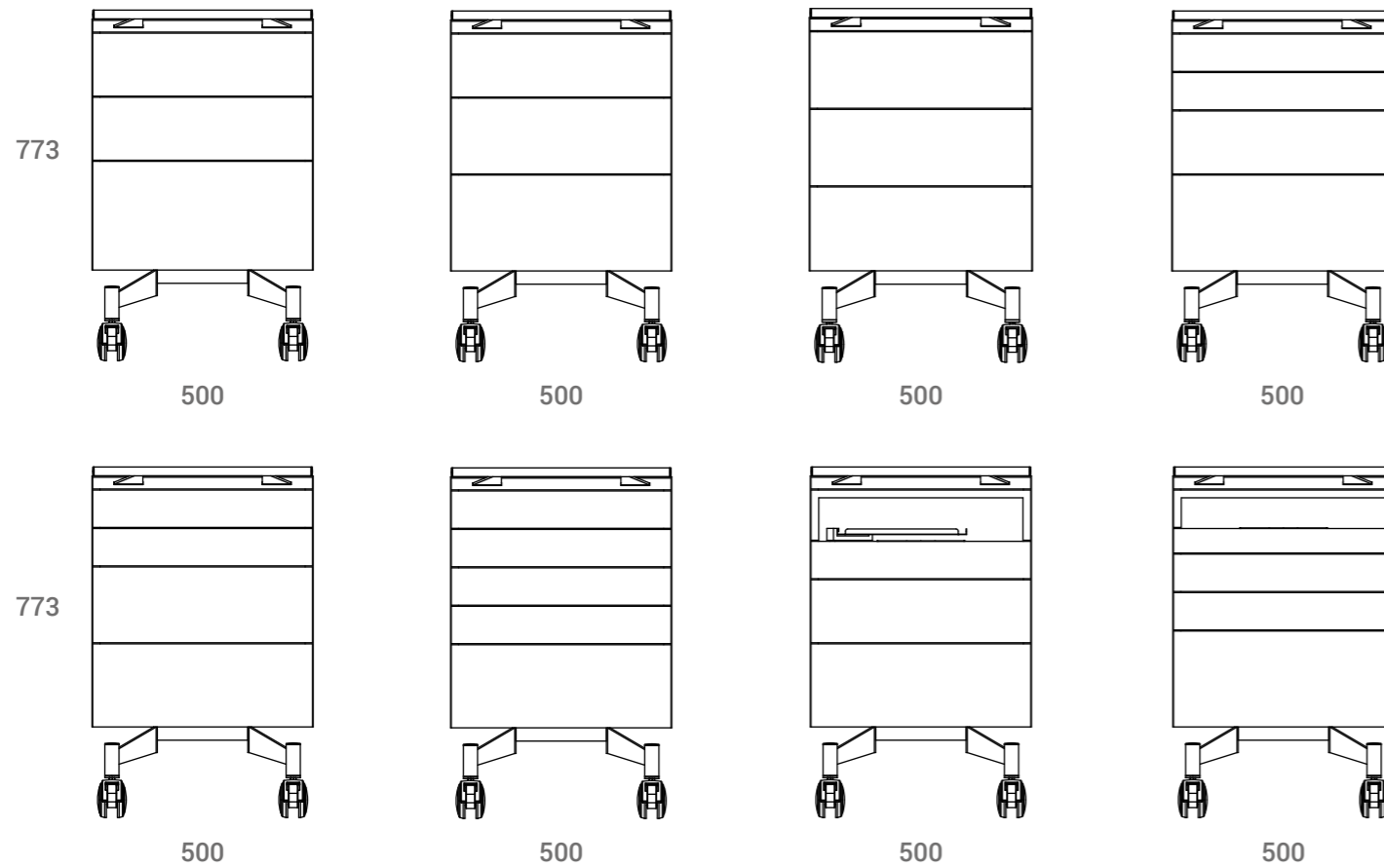

ORGANIZZAZIONE E DESIGN

Con la linea INEUS, ASTRA vuole migliorare l'organizzazione dell'ambiente lavorativo. Nuovi cassetti, nuove bacine interne, nuove guide, nuove cerniere... nulla è casuale nella nuova linea INEUS. Tutto è stato progettato per ottimizzare spazi e flussi di lavoro all'interno dello studio mettendo in primo piano la qualità dei materiali utilizzati e l'estetica della composizione.



ORGANIZATION AND DESIGN

With the INEUS line, ASTRA seeks to improve workplace organization. New drawers, new internal trays, new guides, new hinges—nothing in the INEUS line is accidental. Every element has been designed to optimize space and workflow within the practice, emphasizing quality materials and composition aesthetics.

Vetrine 500 / Hanging Units 500

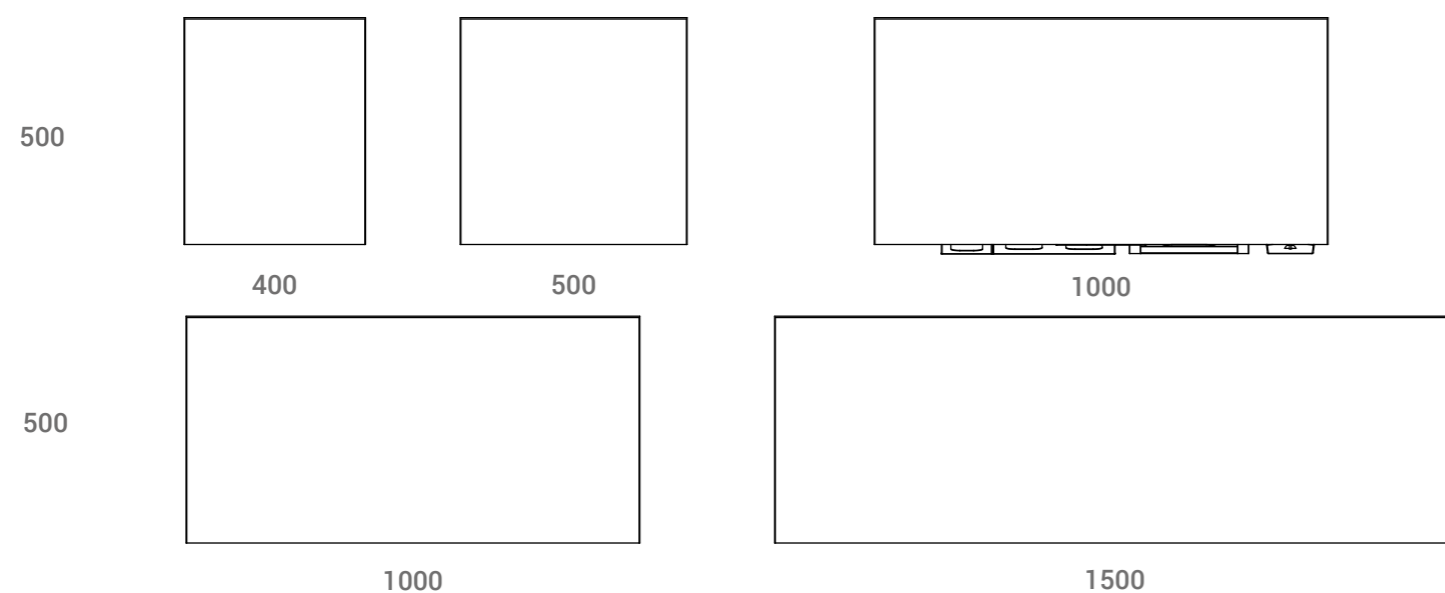

LE INDISPENSABILI

| Accedi al QR qui a fianco e scegli la tua vetrina dispenser.

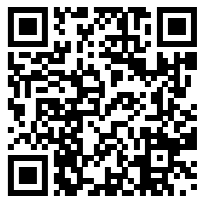

ESSENTIAL ITEMS

| Scan the QR code to select your hanging unit with dispenser.

Fianchi - Tamponamenti vetrine 500 / Side Panels 500

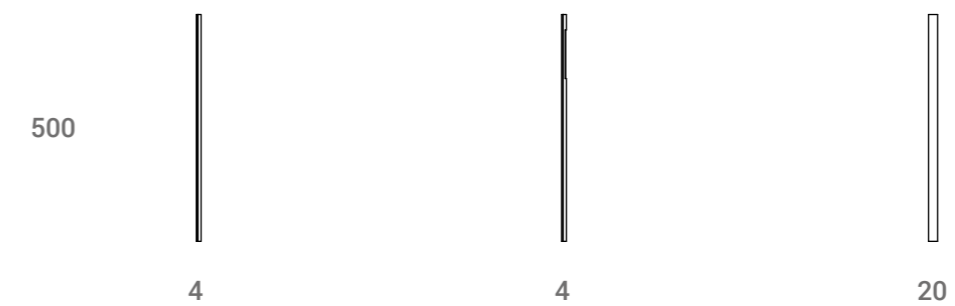

Vetrine 1000 / Hanging Units 1000

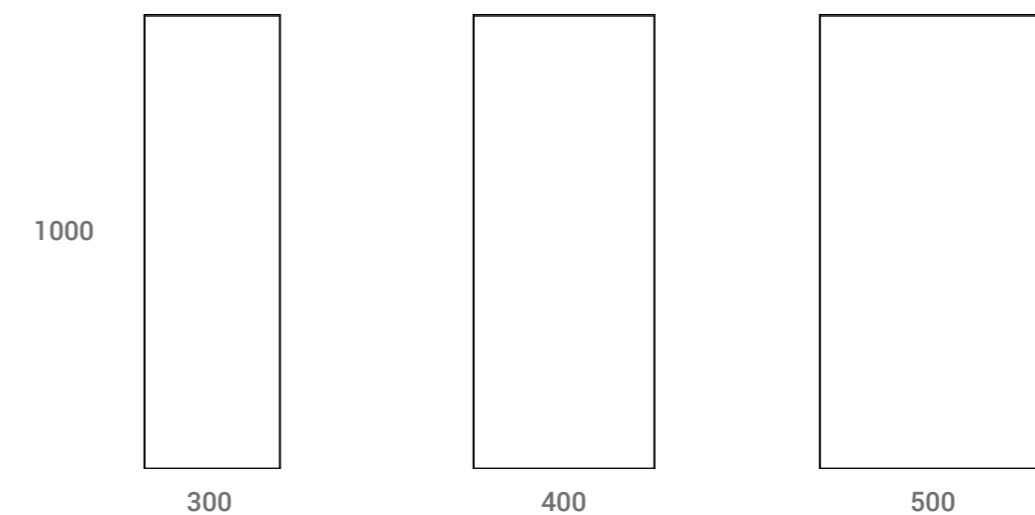

Fianchi - Tamponamenti vetrine 1000 / Side Panels 1000

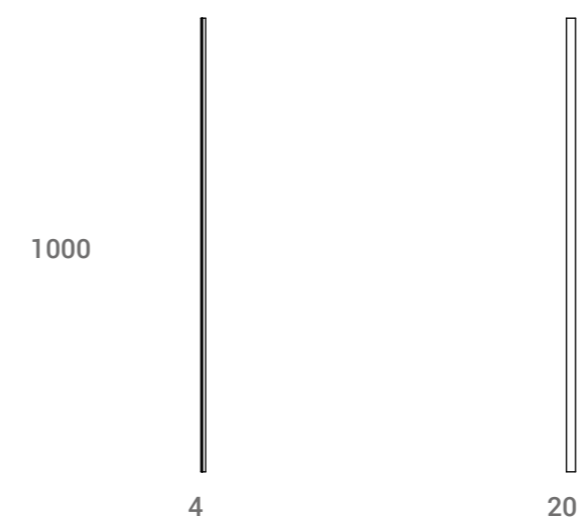

Base 174,5 lavello / Sink Unit 174.5

Base 162 scrivania / Desk Unit 162

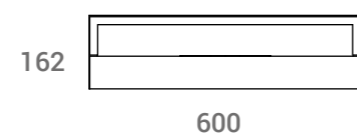
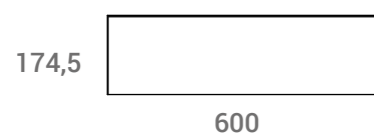

Fianchi - Tamponamenti base 174,5 / Side Panels 174.5

Fianchi - Tamponamenti base 162 scrivania / Side Panels 162



Piani / Worktops

QUALE SOLUZIONE

| Accedi al QR qui a fianco e scegli il tuo piano di lavoro.



WHICH SOLUTION?

| Scan the QR code to choose your worktop.

Lavelli - Miscelatori / Sinks - Mixers

FORME DA SCEGLIERE

| Accedi al QR qui a fianco e scegli il tuo lavabo e miscelatore.



SHAPES TO CHOOSE FROM

| Scan the QR code to select your sink and mixer.

Colori / Colours

COLORE ED EMOZIONE

| Accedi al QR qui a fianco e scegli il colore della tua composizione.



COLOUR AND EMOTION

| Scan the QR code to choose the color of your composition.



Ineus #4

IL LUSO DELLA SEMPLICITÀ

Gli elementi distintivi rispondono ad una serie di codici prestabiliti, ma allo stesso tempo, si definiscono nella ricerca di infiniti dettagli e personalizzazioni con la variabile di mutamento a piacere del cliente che vivrà il proprio studio.

THE LUXURY OF SIMPLICITY

The distinctive elements adhere to predefined standards while offering infinite details and personalization options. Clients can adjust to their preferences, ensuring their practice perfectly reflects their needs.





Con INEUS anche l'apertura ante viene rivoluzionata con la cerniera AIR, sottile di piccole dimensioni, impalpabile ed invisibile proprio come l'aria.

With INEUS, even door openings have been revolutionized with the AIR hinge, a subtle, lightweight, and virtually invisible solution—just like air.



Cassetto ad estrazione totale con bacinelle a scomparti, disponibili in diversi modelli e altezze.

Full-extension drawers with compartmentalized basins are available in various models and heights.



Con INEUS, ASTRA ricerca un'estetica essenziale, gli elementi compositivi vengono interpretati come solidi fondamentali, caratterizzati dall'assenza di maniglie.

With INEUS, ASTRA embraces a minimalist aesthetic, where the design elements are interpreted as fundamental forms, characterized by the absence of handles.



Ineus #5

I SEGNI DEL TEMPO

| Sempre valida e senza tempo la soluzione INEUS con maniglia essenziale per ambienti più classici ma con un tono di colore moderno.

TIMELESS DESIGN

| The INEUS solution with an essential handle remains a timeless option for classic environments, now updated with a modern touch of color.



Equilibrio armonico, la combinazione tra piano argento e mobili nero opaco è la simbiosi perfetta della simmetria delle forze che dona una luce quasi inaspettata alla composizione.

Harmonic balance—the combination of a silver worktop and matte black cabinets achieves the perfect symmetry of forces, adding a nearly unexpected brilliance to the composition.





Nessun ingombro indesiderato, anche nelle vetrine monouso il meccanismo a ribalta è stato integrato nel fianco del mobile. La chiusura dell'anta risulterà fluida e confortevole grazie alla tecnologia soft closing.

No unwanted bulk—hanging units for disposable material feature a flip-up mechanism integrated into the cabinet side. The door's soft-closing technology ensures fluid and comfortable operation.



Le nuove guide a scomparsa della linea INEUS garantiscono una eccellente stabilità e resistenza. Anche il cassetto più pesante scorrerà in modo uniforme e silenzioso, per una apertura e chiusura dolce e senza sforzo.

The new concealed guides in the INEUS line guarantee excellent stability and durability. Even the heaviest drawers slide smoothly and quietly for effortless, seamless opening and closing.

Design & progetto:
Ufficio tecnico Astra
www.astrastyl.it

Fotolito:
Luce Group
fotolito@lucegroup.it

Progetto grafico:
Michele Stefanato

Stampa:
Lithostampa s.r.l.
www.lithostampa.it



MOBILI METALLICI

Via L. Galvani, 8/10 - 33083 Chions (PN)

Tel. 0039 0434 635210 - Fax 0039 0434 635258

www.astrastyl.it - info@astrastyl.it

